

**S83-RTV2S
S177-RTV2S
S180-RTV2S**

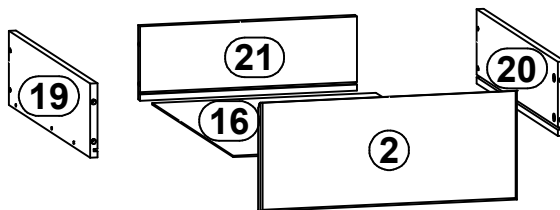

A	B	C	D	
1	S83-015	422	176	4/4
2	S83-016	422	176	4/4
3	S83-128	243	100	1/4
4	S83-130	261	464	1/4
5	S83-131	261	464	1/4
6	S83-132	243	521	1/4
7	S83-133	243	521	1/4
8	S83-1571	370	76	3/4
9	S83-1572	370	76	3/4
10	S83-208	1485	544	2/4
11	S83-314	1411	521	2/4
12	S83-407	406	60	2/4
13	S83-575	90	60	3/4
14	S83-598	294	76	3/4
15	S83-599	294	76	3/4
16	S83-916	368	498	1/4
17	S83-917	270	468	1/4
18	S83-918	270	502	1/4
19	ZS1-503	500	120	1/4
20	ZS1-504	500	120	1/4
21	ZS1-6542	357	120	1/4

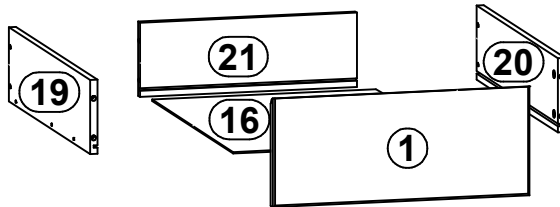
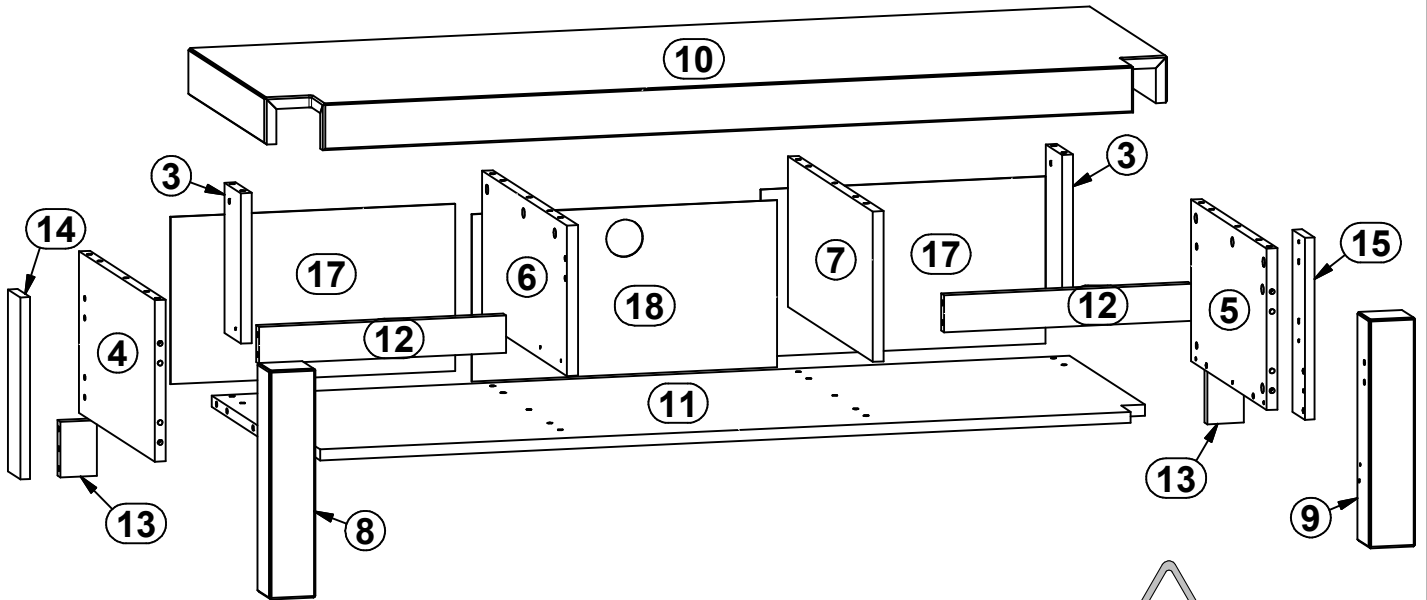
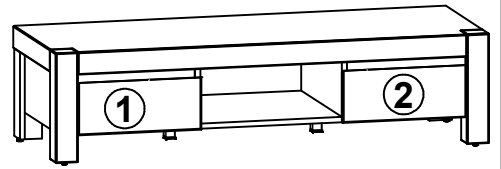
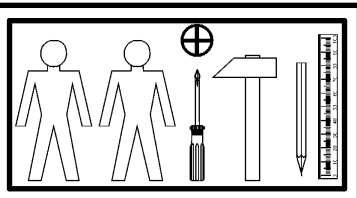

6x φ7x50 mm e1	2x φ6,3x13 mm e2	10x φ6x13 mm e3	12x φ5x9 mm e19	4x φ7x28 mm e22	40x φ8x30 mm f1	4x φ8x20 mm f13	8x φ6,5x40 mm f25	2x k3813
2x k3814	4x M6φ9x14 mm k3912	4x M6φ22mm k3913	55x l1	8x φ3,5x16 mm p38	26x φ1,5x12mm #16 r1	8x φ12x10,5mm #12 r15	34x r42	2x 500 mm w26\CL
2x 500 mm w26\CR	2x 500 mm w26\DL	2x 500 mm w26\DR	1x z1	1x n26\I	1x φ3,5x16 mm p38			

1

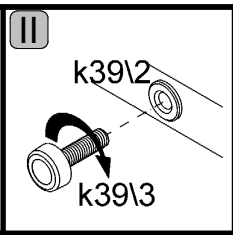
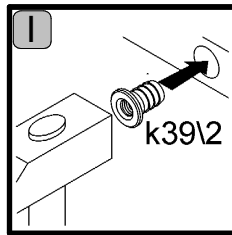
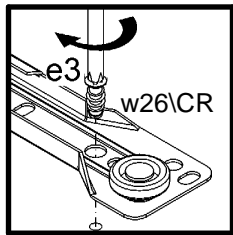
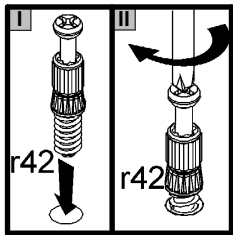
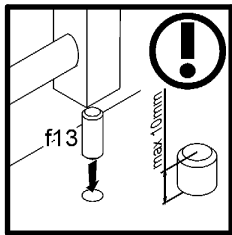
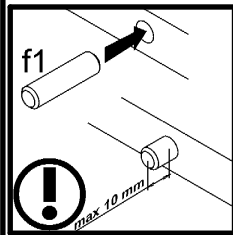
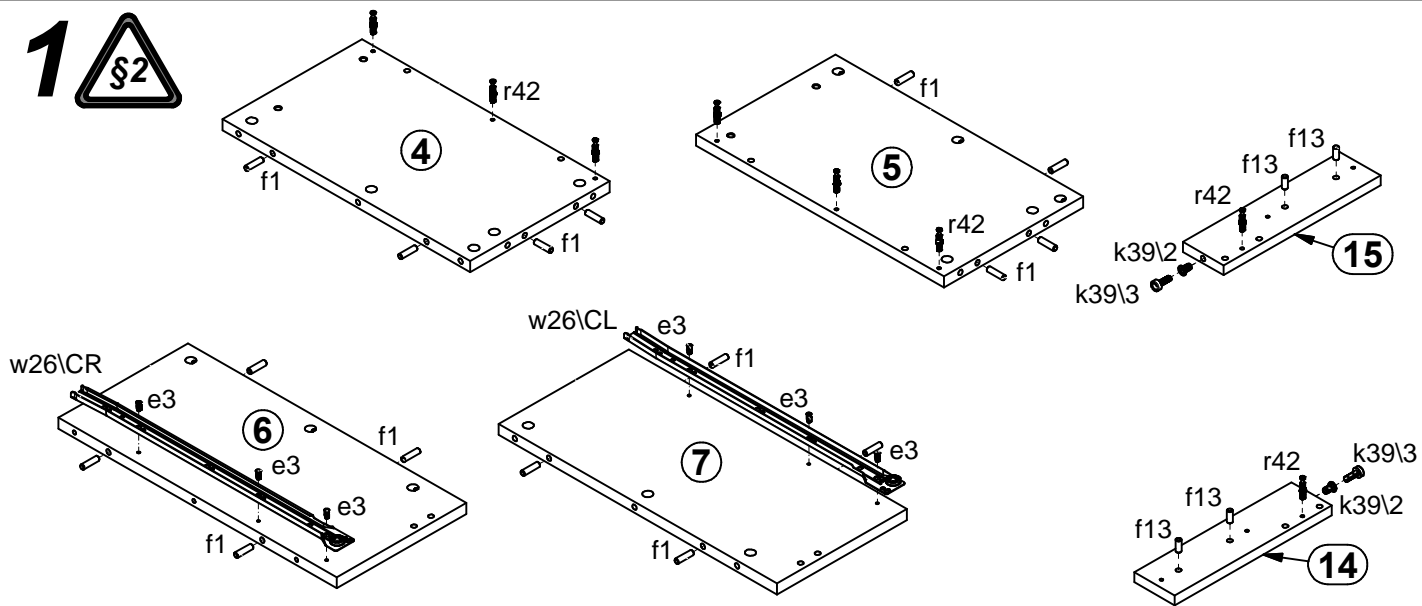

2

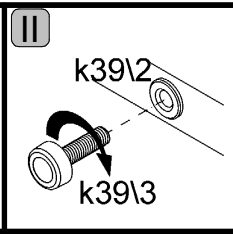
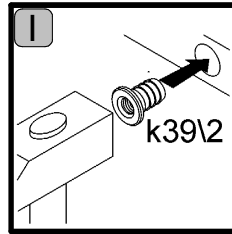
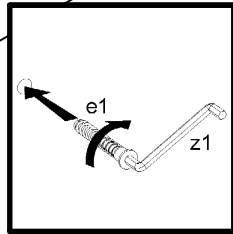
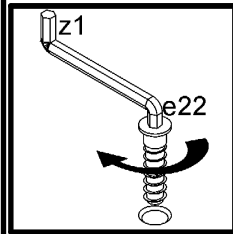
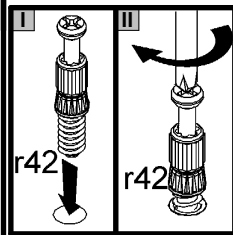
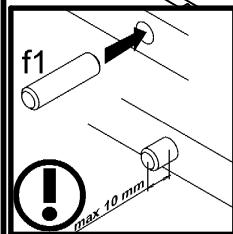
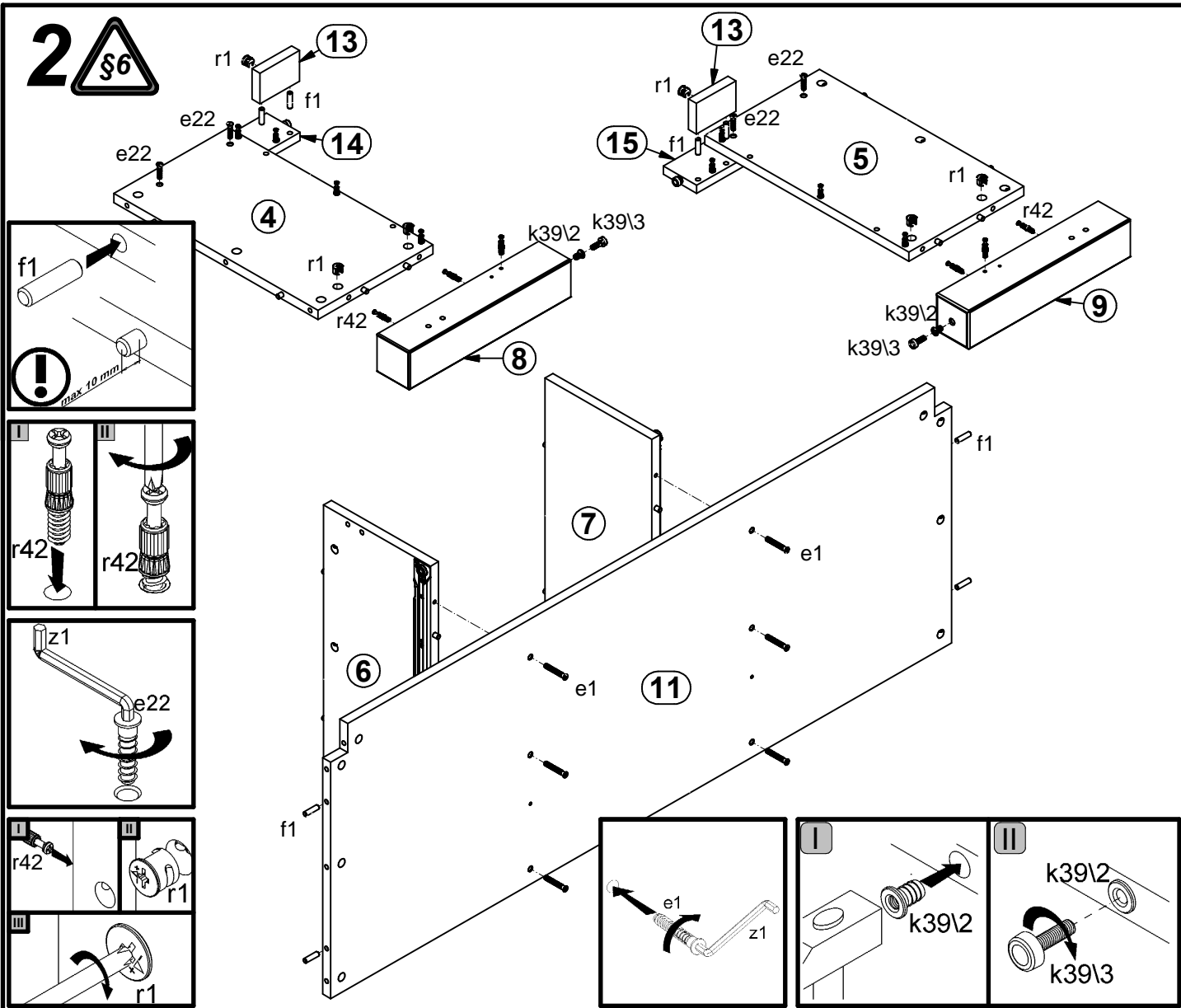

6

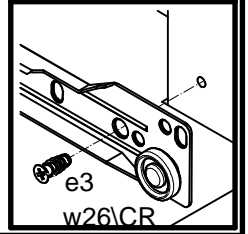
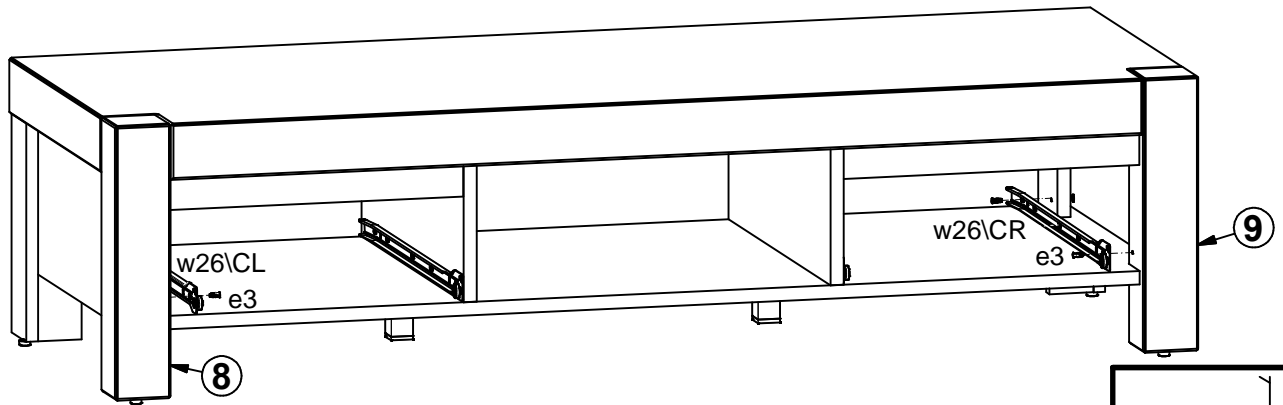

7

